

# Drilling position measurement

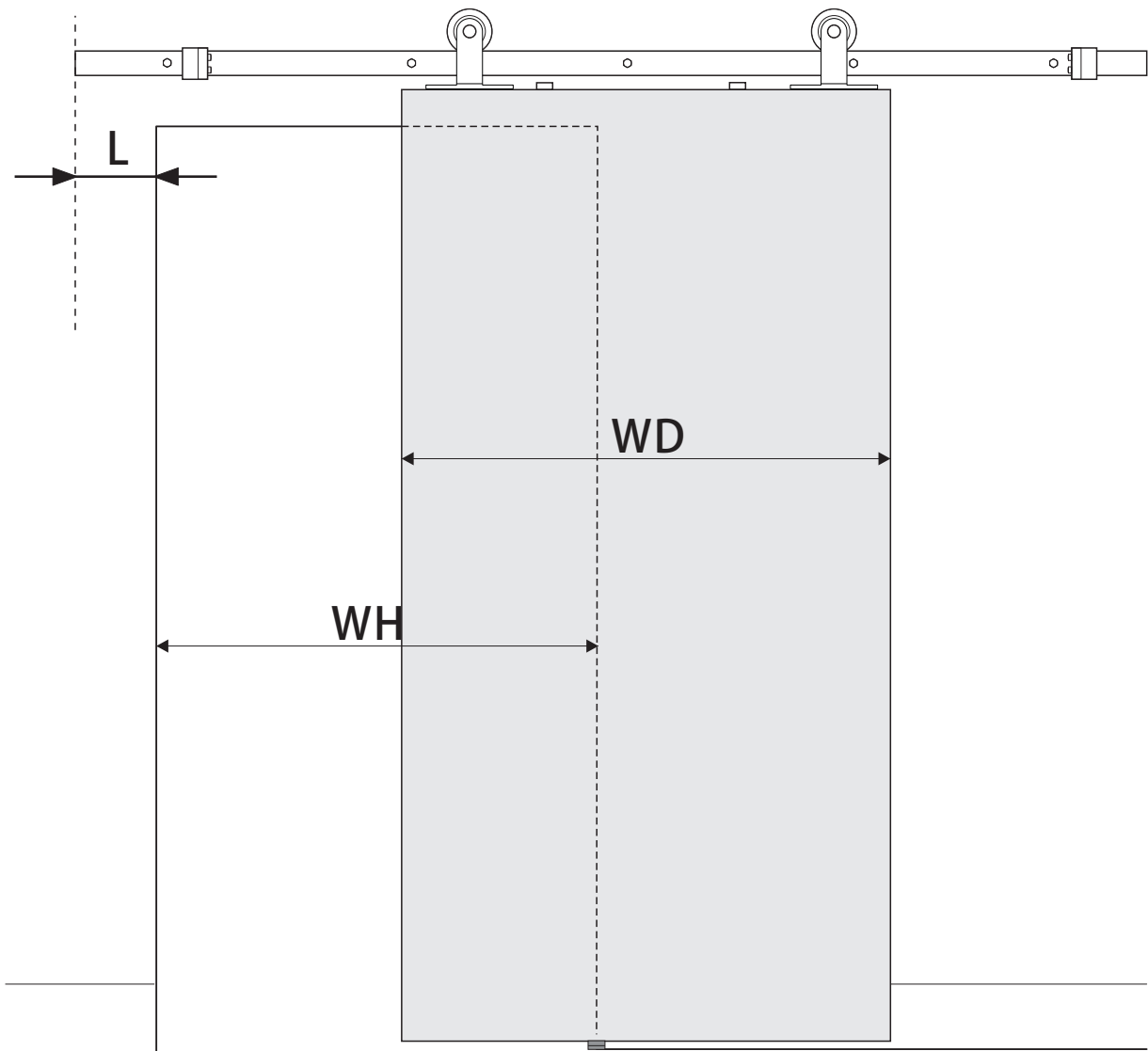

D(mm)	L(mm)
70	$78 + (WD - WH) / 2$
100	$48 + (WD - WH) / 2$
150	$38 + (WD - WH) / 2$

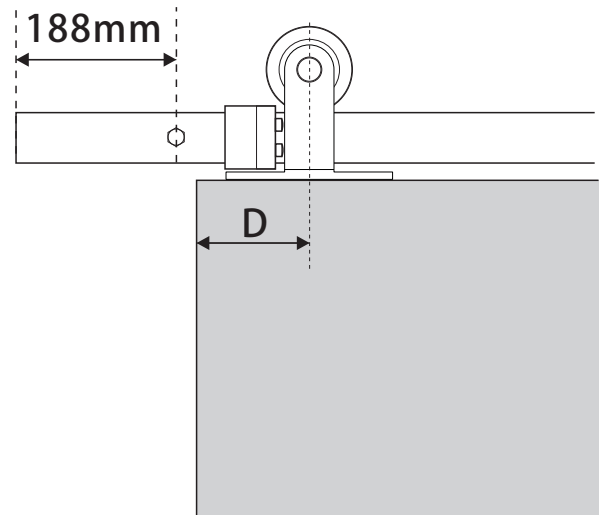

# Installation Manual

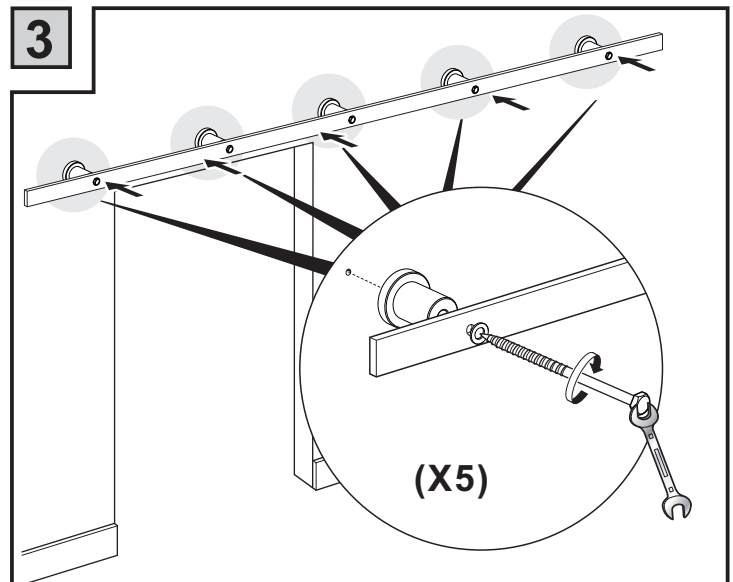
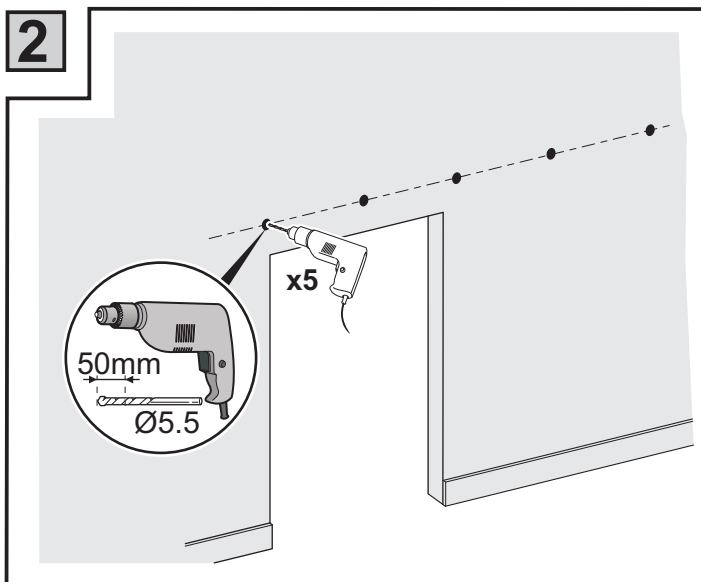
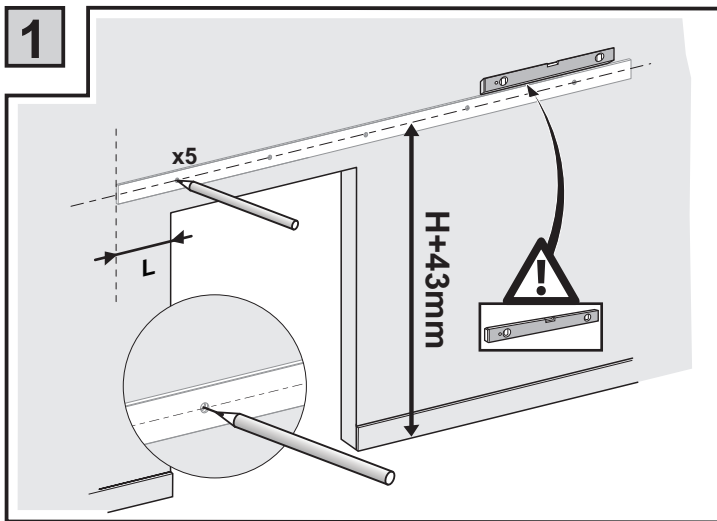
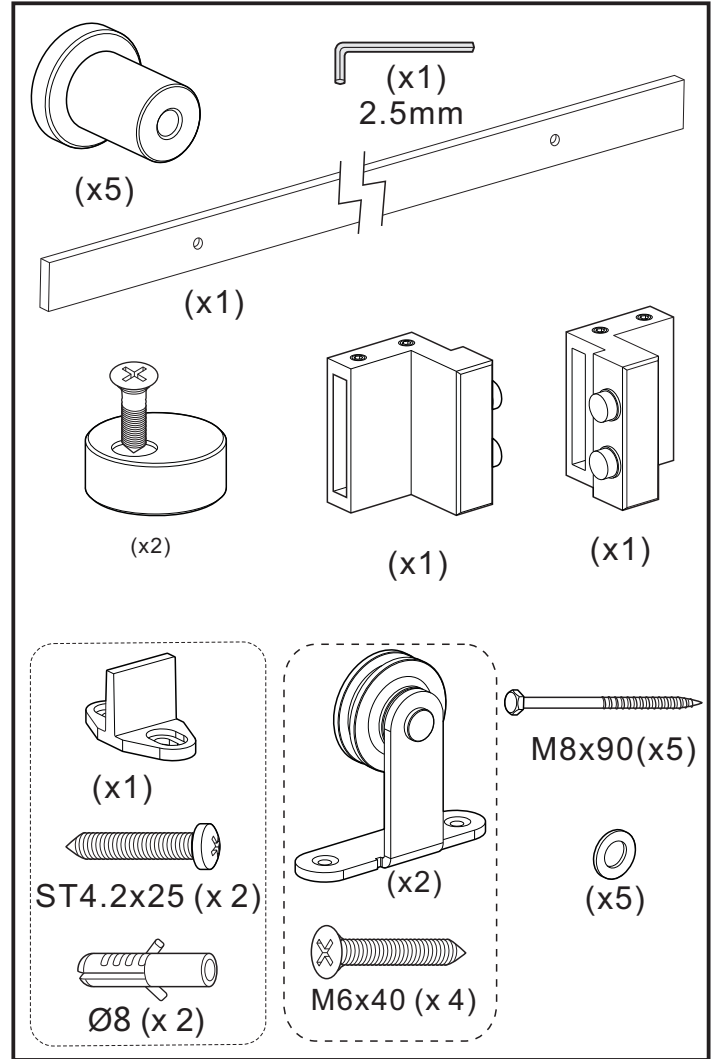
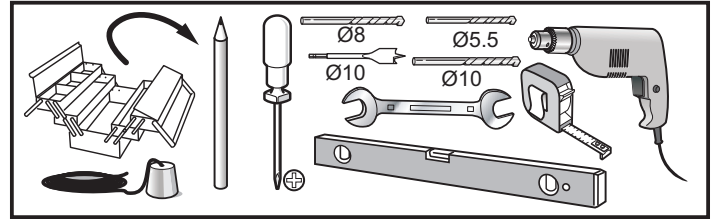
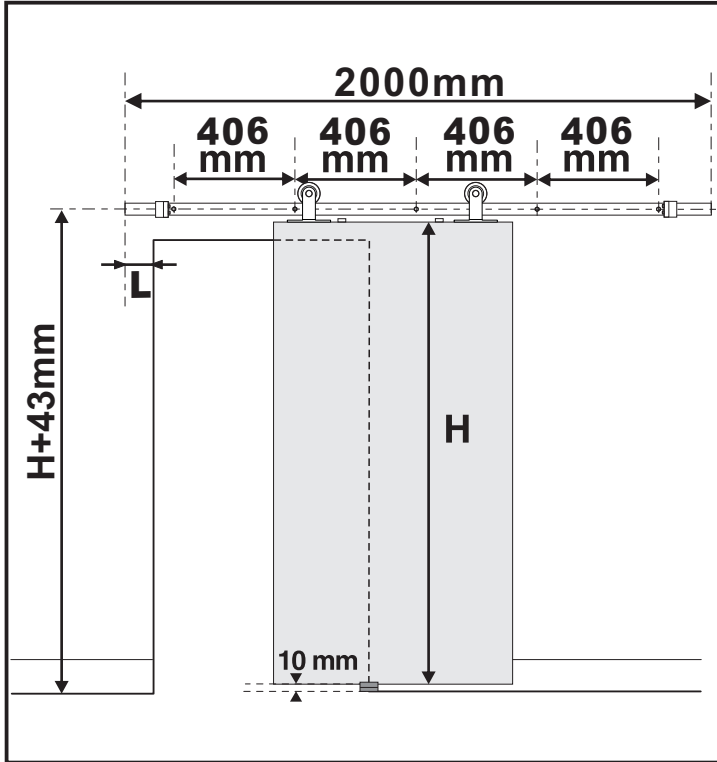

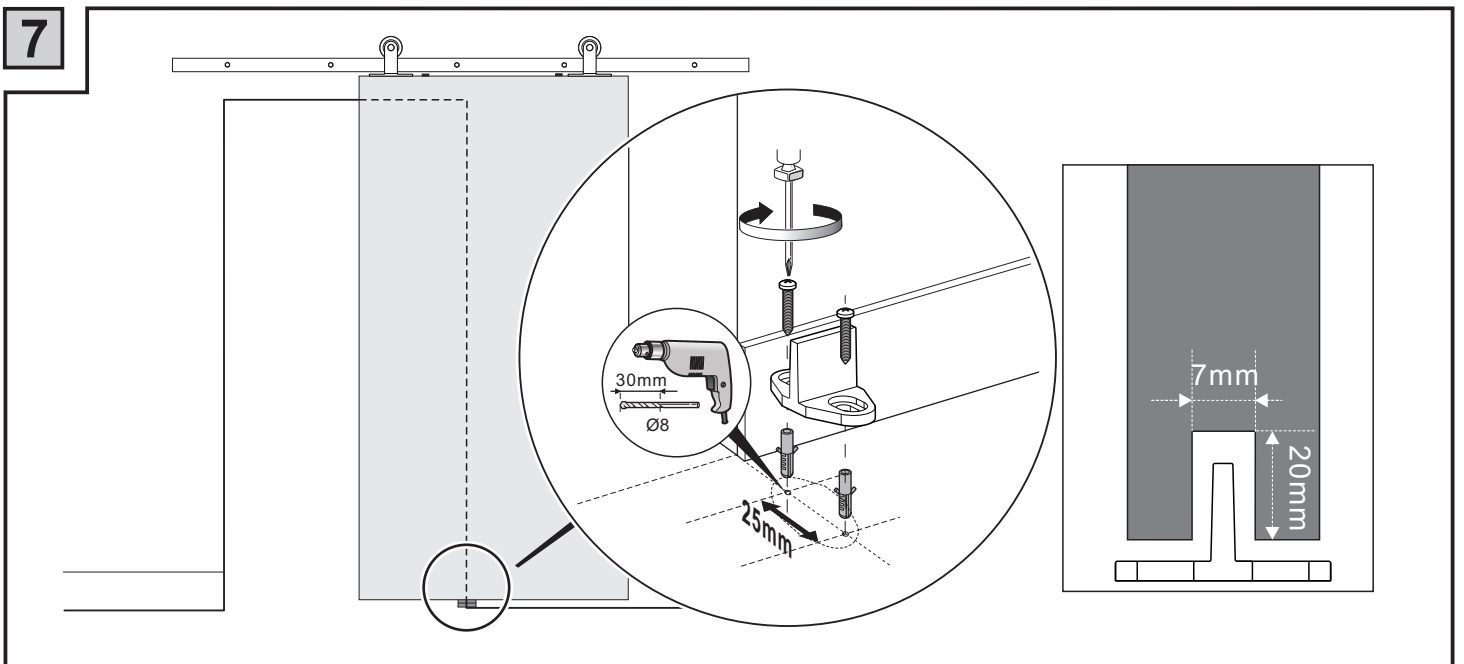
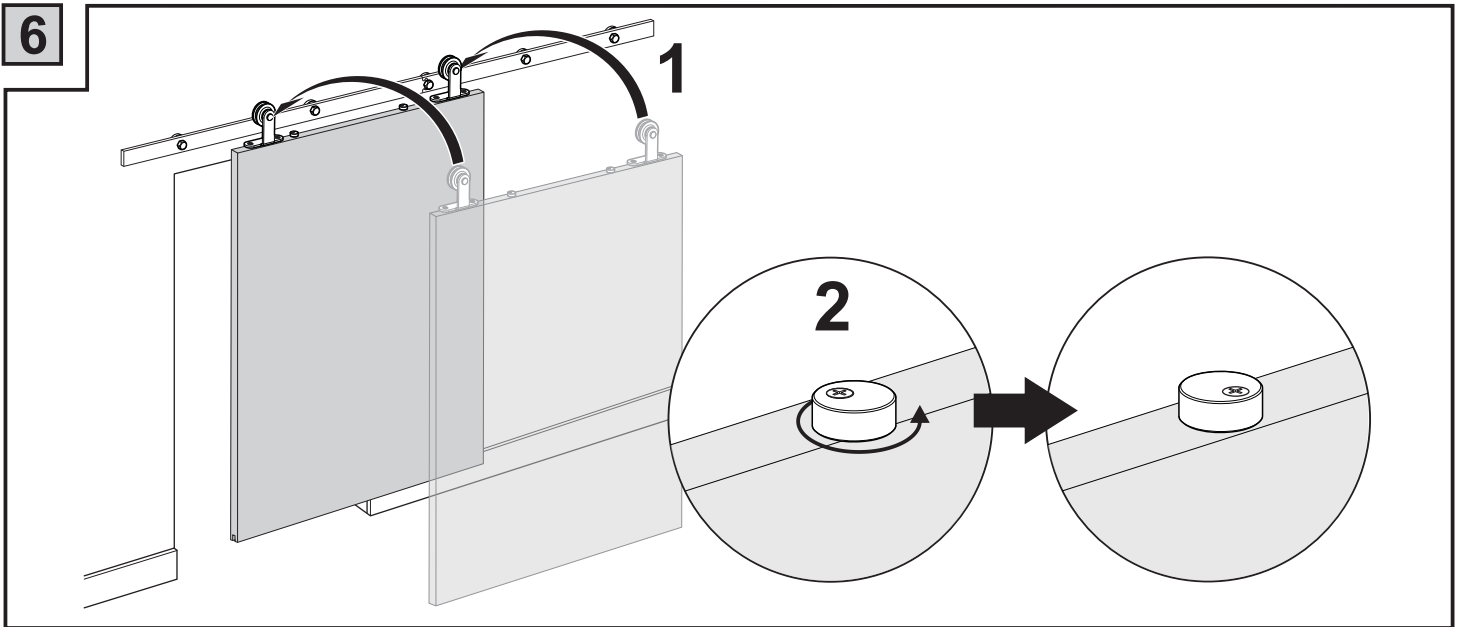
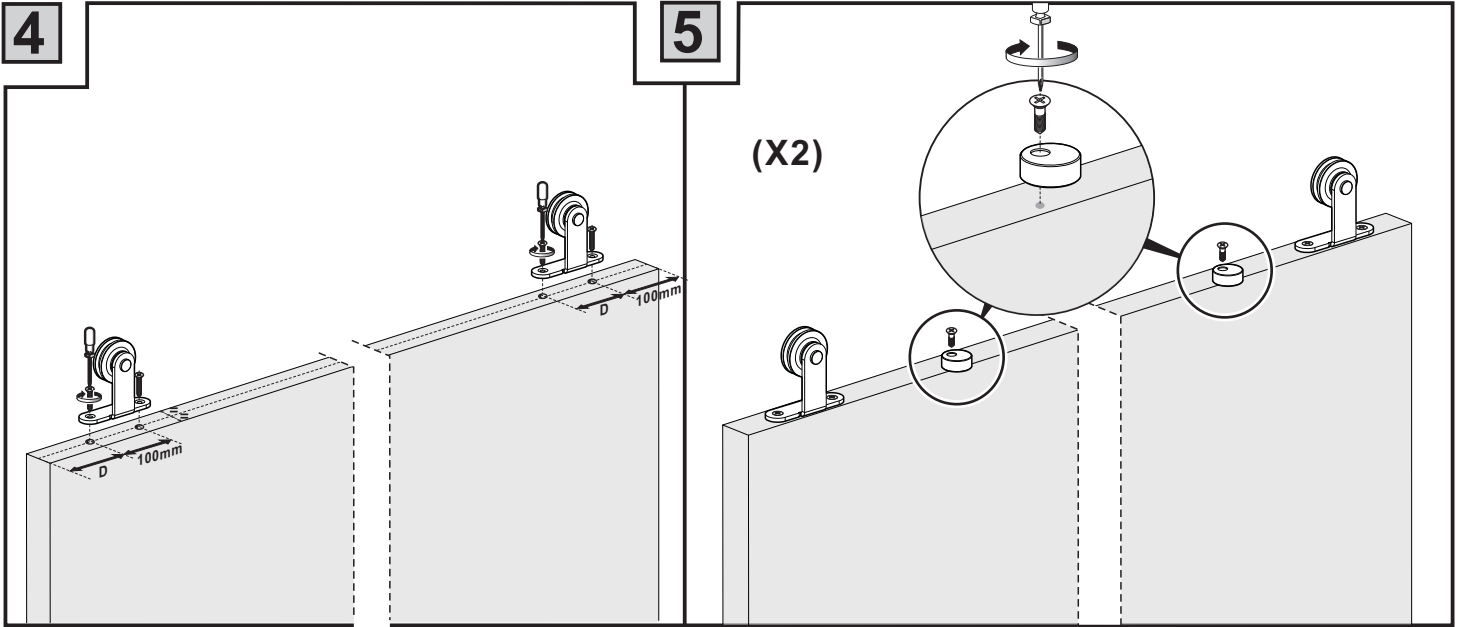

8

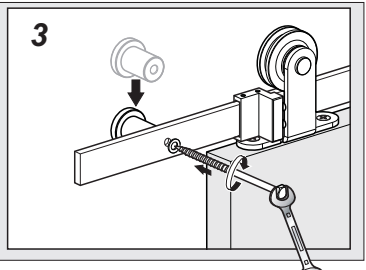
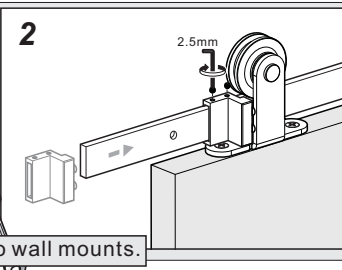
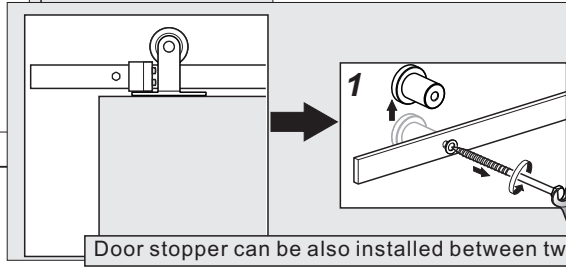
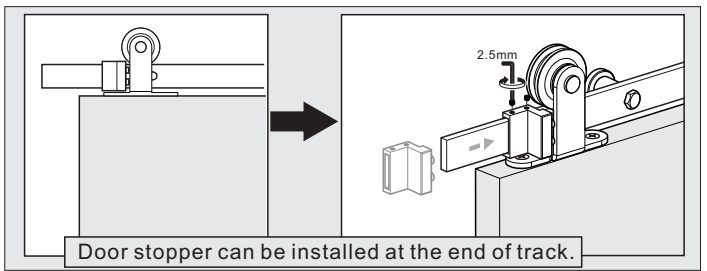
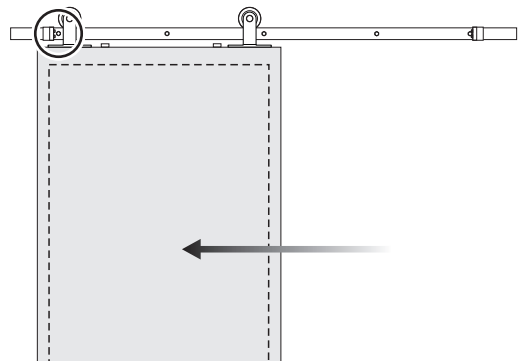

9

